

HT10

Laser light scanner with background suppression

en 02-2016/08 50130292-01



50 ... 8000mm



- Laser scanner with large detection range for universal application (visible red light)
- Light propagation time measurement makes use possible under extreme environmental conditions (brightness, light, interfering contours)
- Extremely simple operation, teachable switching points
- Minimum teach duration prevents unintentional changing of the switching points
- Preset hysteresis and reserve ensure reliable switching behavior
- Switching behavior independent of the direction of movement
- Optimized for positioning tasks and reliable object detection (e.g. compartment occupancy monitoring, shelf positioning)

We reserve the right to make changes • DS_HT10_en_50130292_01.fm



Accessories:

(available separately)

- Mounting systems
- Cable with M12 connector (K-D ...)
- IO-Link master set
SET MD12-US2-IL1.1 + accessories - diagnostics set (part no. 50121098)

Dimensioned drawing

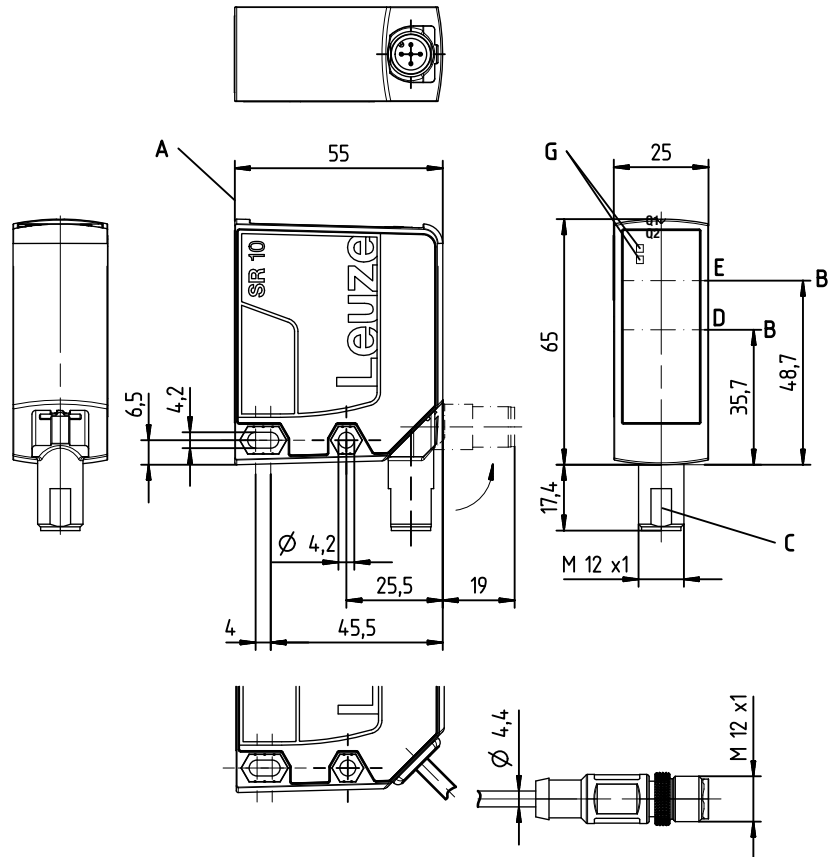

- A Reference edge for the measurement
- B Optical axis
- C Turning M12 connector, 90°
- D Receiver
- E Transmitter
- G Indicator diodes green/red (control panel)
2 x yellow (control panel and lens cover)
- H Key pad

Electrical connection

HT10L1.3/L69-M12
HT10L1.3/L69,200-M12

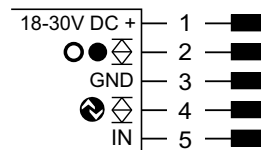

HT10L1.3/L69

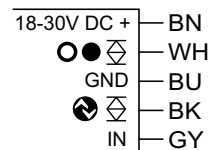

HT10L1.3/L66-M12
HT10L1.3/L66,200-M12

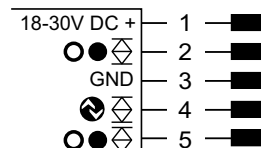

HT10L1.3/L66

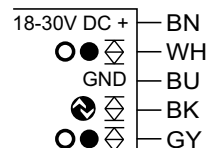

HT10L1.3/L6X-M12
HT10L1.3/L6X,200-M12

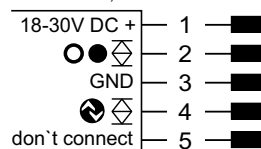

HT10L1.3/L6X

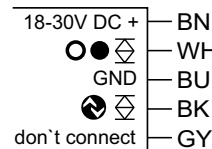

Specifications

Optical data

Typ. scanning range limit (white 90%) ¹⁾	50 ... 8000mm
Scanning range ²⁾	50 ... 3500mm
Adjustment range (teach-in range)	50 ... 8000/3500mm (90%/6% diffuse reflection)
Light source	laser
Laser class	1 (acc. to IEC 60825-1:2007)
Wavelength	658nm (visible red light)
Impulse duration	6ns
Max. output power (peak)	391mW
Light spot	approx. 7x7mm ² at 7m

Error limits

Accuracy ³⁾	± 30mm
B/W detection thresh. (6 ... 90% rem.)	± 10mm
Temperature drift	± 2mm/K

Timing

Switching frequency	40Hz
Response time	< 50ms
Delay before start-up	≤ 300ms

Electrical data

Operating voltage U _B ⁴⁾	18 ... 30VDC (incl. residual ripple)
Residual ripple	≤ 15% of U _B
Open-circuit current	≤ 150mA
Switching output	.../...6... push-pull switching output ⁵⁾ , PNP light switching, NPN dark switching
Signal voltage high/low	≥ (U _B -2 V) ≤ 2V
IO-Link	COM2 (38.4kBaud), vers. 1.1, min. cycle time 2.3ms, SIO is supported

Indicators

Green/red LED	green continuous light	ready
	red	no signal
	orange	warning, weak signal
	off	no voltage
Yellow LEDs Q1/Q2	on	object detected
	off	object not detected

Mechanical data

Housing	plastic
Optics cover	glass
Weight	70g (M 12 connector) 133g (2m cable) 90g (cable with M 12 connector)
Connection type	turning M 12 connector, 90° 2m cable, core cross section 5 x 0.14mm ² (5 x 26 AWG) 0.2m cable with M12 connector

Environmental data

Ambient temp. (operation/storage)	-40 °C ... +50 °C / -40 °C ... +70 °C
Protective circuit ⁶⁾	1, 2, 3
VDE safety class	III
Degree of protection	IP 67
Standards applied	IEC 60947-5-2
Certifications	UL 508, CSA C22.2 No.14-13 ^{4) 7)}

Options

Deactivation input	
Transmitter inactive/active	≥ 8V/≤ 2V ⁸⁾
Activation/disable delay	≥ 20ms
Input resistance	approx. 10kΩ

- 1) Typ. scanning range limit: guaranteed scanning range against 90% at maximum setting
- 2) Scanning range: recommended range with function reserve
- 3) For 50 ... 3500mm measurement range, luminosity coefficient 6% ... 90%, "Speed" operating mode, at 20 °C after 20min. warmup time, medium range of U_B, measurement object ≥ 50x50mm²
- 4) For UL applications: use is permitted exclusively in Class 2 circuits according to NEC
- 5) The push-pull switching outputs must not be connected in parallel
- 6) 1=transient protection, 2=polarity reversal protection, 3=short circuit protection for all outputs
- 7) These proximity switches shall be used with UL Listed Cable assemblies rated 30V, 0.5A min, in the field installation, or equivalent (categories: CYJV/CYJV7 or PVVA/PVVA7)
- 8) Upon deactivation of the laser, the outputs become inactive

Remarks

- You can download the IO Device Description (IODD file) and the *Sensor Studio* configuration software (requires IO-Link USB master) from the Internet at www.leuze.com.

Tables

Switching points ¹⁾	no reflection	object detected
Yellow LED Q 1	off	on
Yellow LED Q 2	off	on

1) applies for object teach

Diagrams

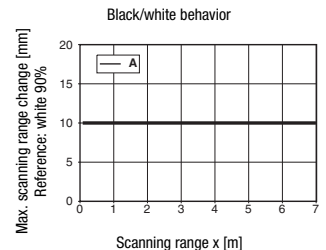

A 6 ... 90% diffuse reflection

Remarks

Adjusting the switching points

- **Object teach:**
Align sensor with object.
Q1: Press teach button 1 for approx. 2s,
Q2: Press teach button 2 for approx. 2s,
Q3: Press teach buttons 1+2 for approx. 2s.
Switching point is taught.
Object is detected if the respective Q1/ Q2 indicator illuminates. No LED present for Q3.
- **Teach against background:**
Point sensor at background.
Q1: Press teach button 1 for approx. 7s,
Q2: Press teach button 2 for approx. 7s,
Q3: Press teach buttons 1+2 for approx. 7s.
Switching point is taught.
Objects between sensor and background are detected.
- **Hysteresis:**
To ensure continuous object detection in the switching point, the sensor has a switch hysteresis.
Object is no longer detected if: distance to sensor > teach point + hysteresis + reserve.
- **Factory setting:**
hysteresis: approx. 50mm
reserve: approx. 50mm.
- With the set scanning range, a tolerance of the upper scanning range limit is possible depending on the reflection properties of the material surface.
- Scanning range/reflectivity:

Object/diffuse reflection	
6%	0.05 ... 3.5m
90%	0.05 ... 8m

Operate in accordance with intended use!

- ⚠ This product is not a safety sensor and is not intended as personnel protection.
- ⚠ The product may only be put into operation by competent persons.
- ⚠ Only use the product in accordance with the intended use.

HT10

Laser light scanner with background suppression

Laser safety notices



ATTENTION, LASER RADIATION – LASER CLASS 1

The device satisfies the requirements of IEC 60825-1:2007 (EN 60825-1:2007) safety regulations for a product in **laser class 1** as well as the U.S. 21 CFR 1040.10 regulations with deviations corresponding to "Laser Notice No. 50" from June 24th, 2007.

- ↳ Adhere to the applicable legal and local regulations regarding protection from laser beams.
- ↳ The device must not be tampered with and must not be changed in any way.
 - There are no user-serviceable parts inside the device.
 - Repairs must only be performed by Leuze electronic GmbH + Co. KG.

IO-Link process data format

(IO-Link 1.1, M-sequence TYPE_2_1)

Output data device (8 bit)

Data bit								Assignment	Meaning
7	6	5	4	3	2	1	0		
								Switching output Q1	0 = inactive, 1 = active
								Switching output Q2	0 = inactive, 1 = active
								Switching output Q3	0 = inactive, 1 = active (if Q3 not present = 0)
								Measurement	0 = initialization/teach/deactivation, 1 = running measurement
								Signal	0 = no signal or signal too weak, 1 = signal ok
								Warning	0 = no warning, 1 = warning, e.g., weak signal
								0	Not assigned (initial state = 0)
								0	Not assigned (initial state = 0)

Input data device

None

Part number code

H	T	1	0	L	1	.	3	/	L	6	9	,	2	0	0	-	M	1	2
---	---	---	---	---	---	---	---	---	---	---	---	---	---	---	---	---	---	---	---

Operating principle

HT Laser light scanner with background suppression

Series

10 Series 10

Laser class

L1 Laser class 1 (acc. to IEC 60825-1:2007)

Equipment

3 Membrane keyboard for teach-in

Assignment pin 4

L IO-Link (with dual channel, also push/pull switching output)

Assignment pin 2

6 Push/pull switching output

Assignment pin 5

9 Deactivation input (factory setting) or teach input (> 8VDC, configurable)

6 Push/pull switching output

X Do not connect

Electrical connection

-M12 M12 connector, 5-pin

,YYYY Cable, length YYYYmm with wire-end sleeves, 5-wire (not specified = standard length 2000mm)

,200-M12 Cable, length 200mm with M12 connector, 5-pin

Order guide

	Designation	Part no.
Connection: M12 connector, 5-pin		
IO-Link 1.1/switching output, 1 push/pull switching output, deactivation input	HT10L1.3/L69-M12	50129537
IO-Link 1.1/switching output, 2 push/pull switching outputs	HT10L1.3/L66-M12	50129540
IO-Link 1.1/switching output, 1 push/pull switching output	HT10L1.3/L6X-M12	50128388
Connection: cable, length 2000mm with wire-end sleeves, 5-wire		
IO-Link 1.1/switching output, 1 push/pull switching output, deactivation input	HT10L1.3/L69	50129542
IO-Link 1.1/switching output, 2 push/pull switching outputs	HT10L1.3/L66	50129546
IO-Link 1.1/switching output, 1 push/pull switching output	HT10L1.3/L6X	50129543
Connection: cable, length 200mm with M12 connector, 5-pin		
IO-Link 1.1/switching output, 1 push/pull switching output, deactivation input	HT10L1.3/L69,200-M12	50129549
IO-Link 1.1/switching output, 2 push/pull switching outputs	HT10L1.3/L66,200-M12	50129551
IO-Link 1.1/switching output, 1 push/pull switching output	HT10L1.3/L6X,200-M12	50129548
Accessories		
Mounting system for mounting on rods Ø 10 mm	BTU 460M-D10	50128379
Mounting system for mounting on rods Ø 12 mm	BTU 460M-D12	50128380
Connection cable with M12 connector, angled, 5-pin, length 2m, PVC sheathing (many other connection cables are available)	K-D M12W-5P-2m-PVC	50104556
IO-Link master set	SET MD12-US2-IL1.1 + accessories - diagnostics set	50121098